

Etapas del desarrollo de la gramática de formas

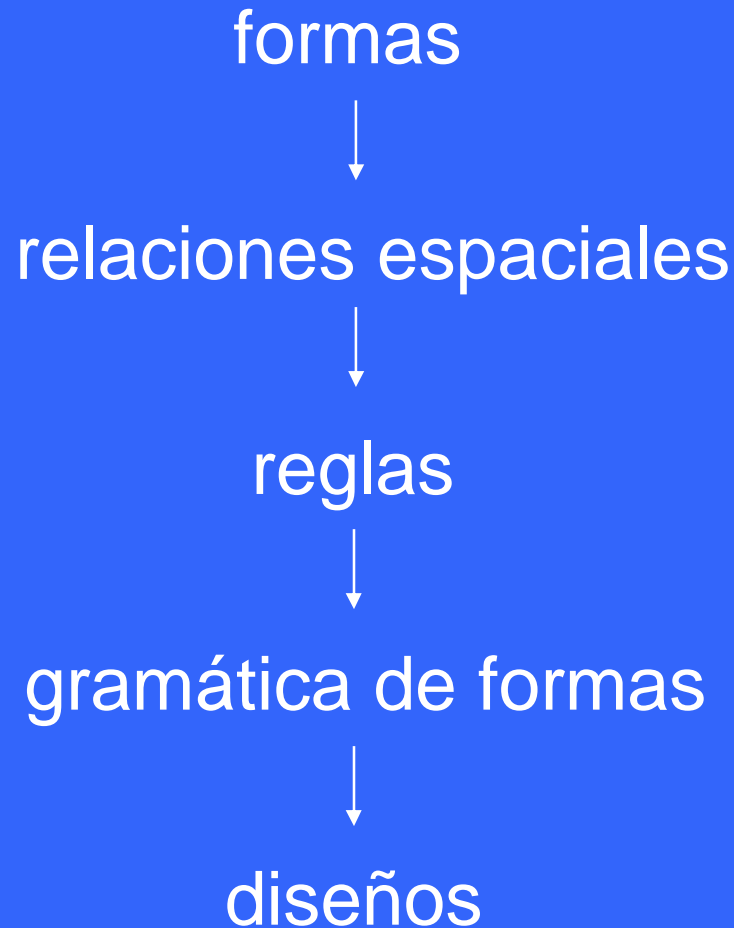

formas

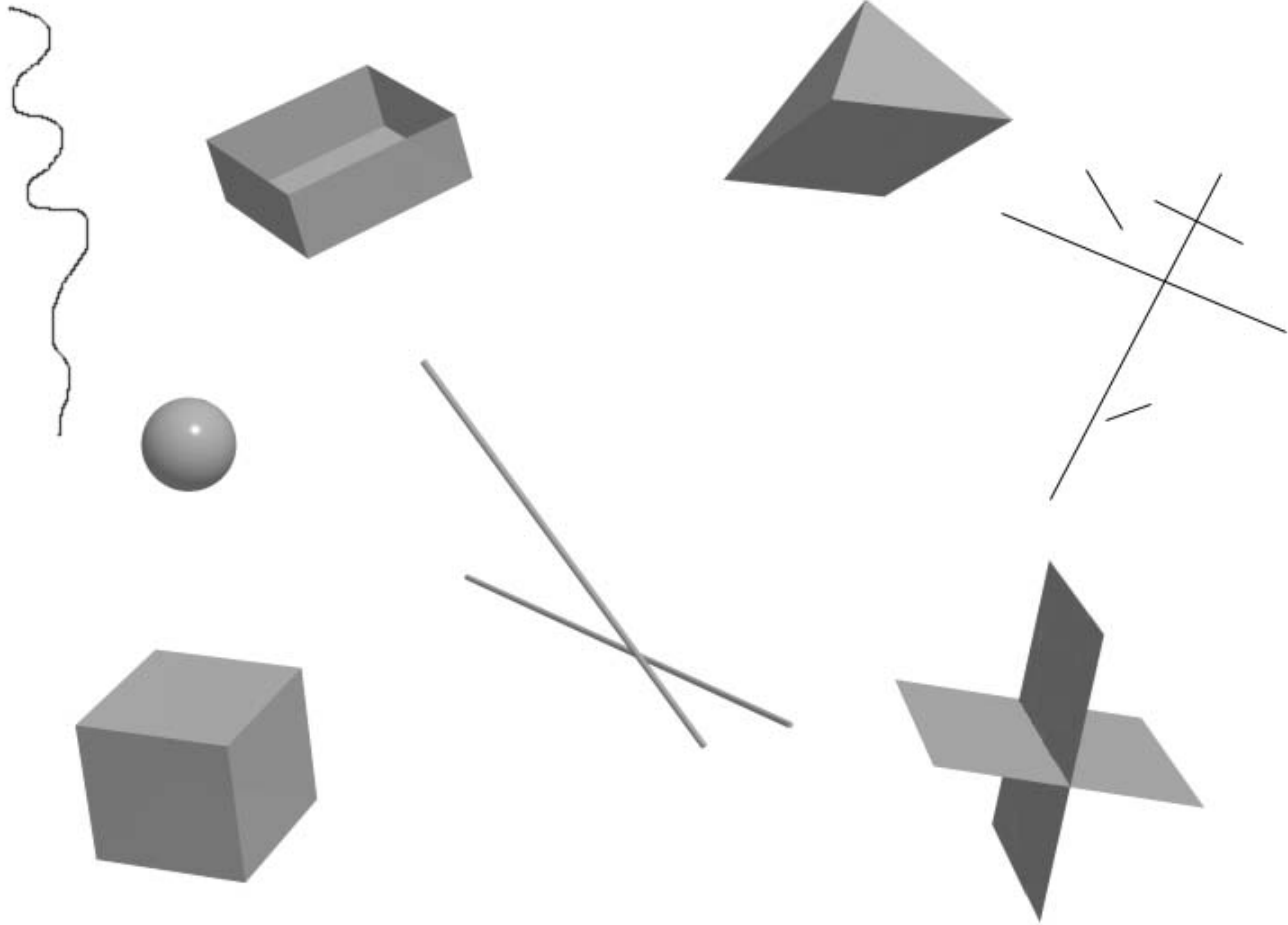

Dotes de construcción de Froebel

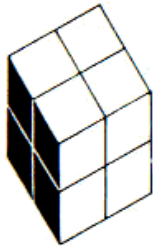

Gift 3

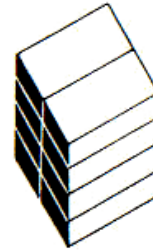
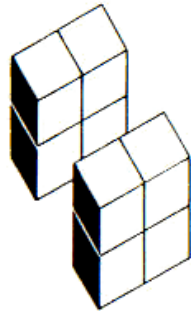

Gift 4

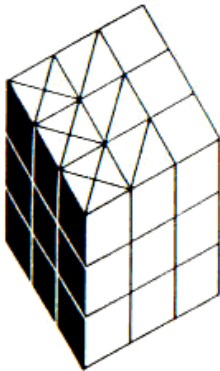
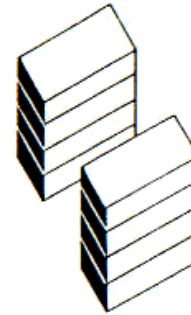

Gift 5

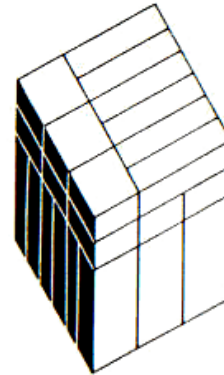
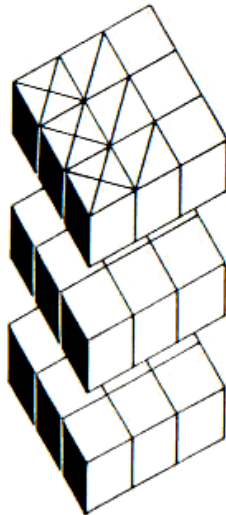

Gift 6

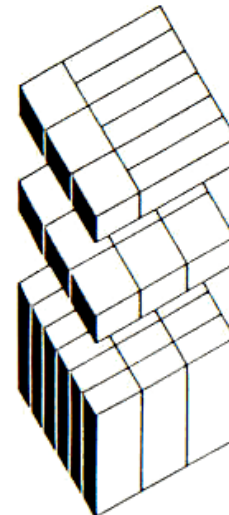

relaciones espaciales

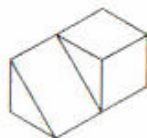
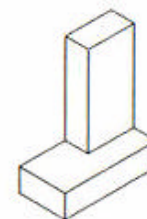
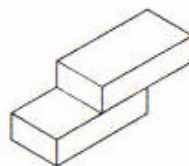
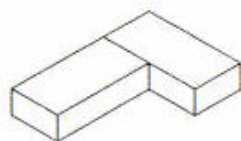
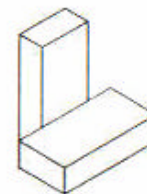
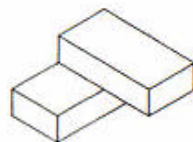
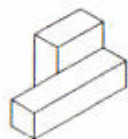

reglas de forma

formas: A, B

relación espacial: $A + B$

reglas:
 $A \rightarrow A + B$
 $B \rightarrow A + B$

relación espacial

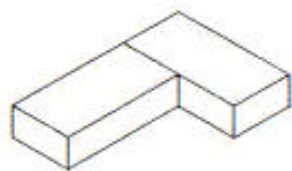

regla

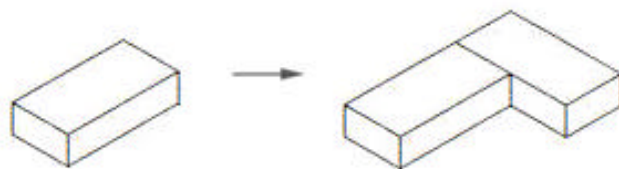

relación espacial

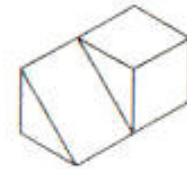
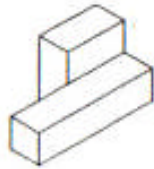

reglas

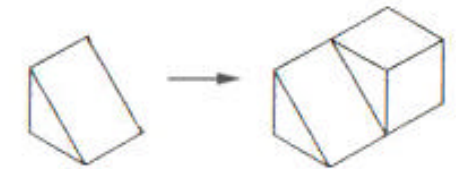
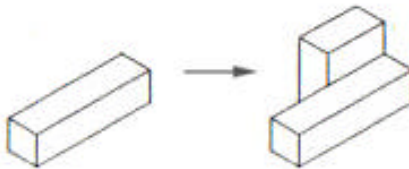
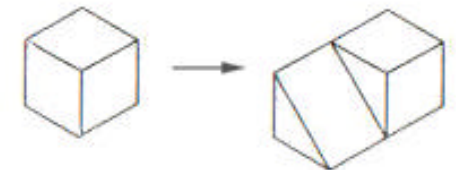
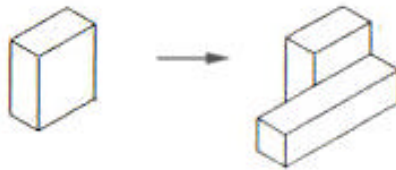

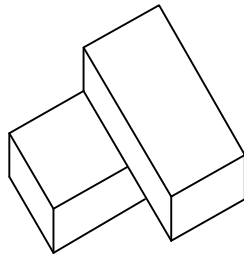

relación espacial $A + B$ entre dos rectángulos

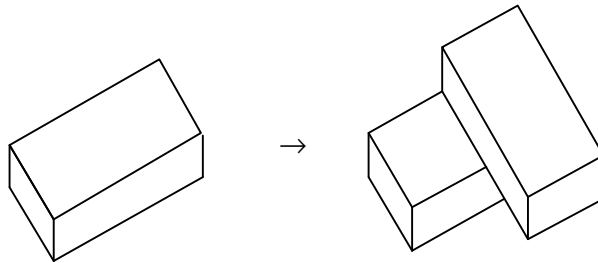

regla de adición $A \rightarrow A + B$ basada en la relación espacial

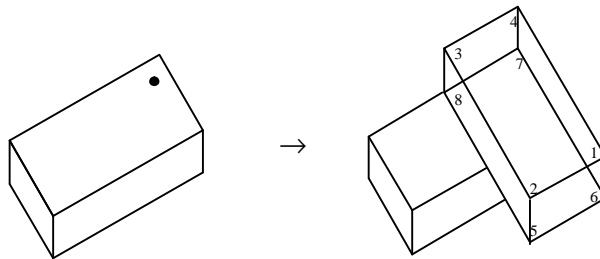

diferentes etiquetados de una regla $A \rightarrow A + B$

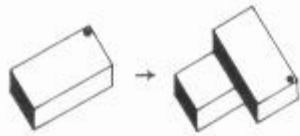

regla



diseño

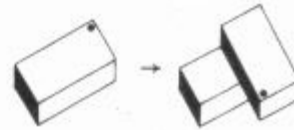

regla

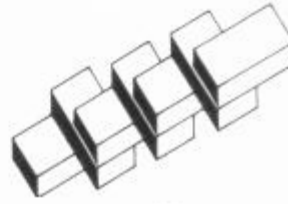

diseño

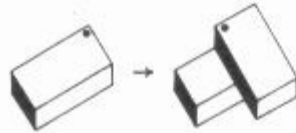

regla



diseño

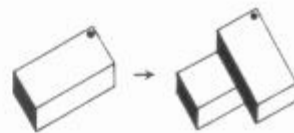

regla



diseño

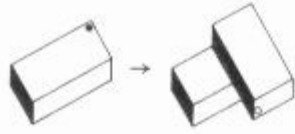

regla

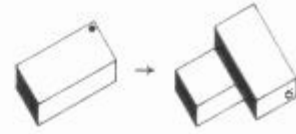

regla

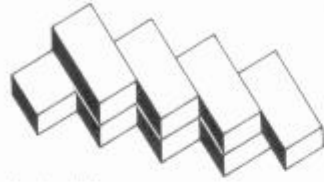

diseño



diseño

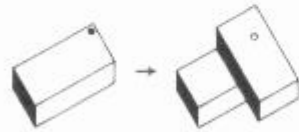

regla

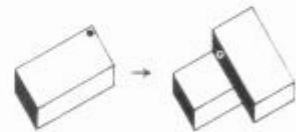

regla



diseño



diseño

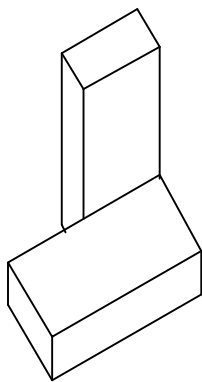

relación espacial $A + B$ entre dos rectángulos

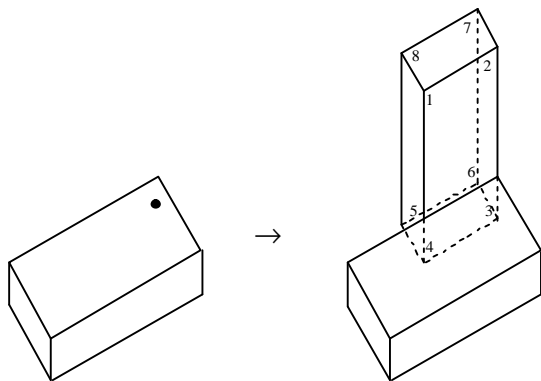

diferentes etiquetados de una regla $A \rightarrow A + B$

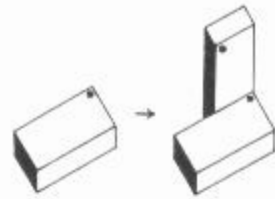

regla



diseño

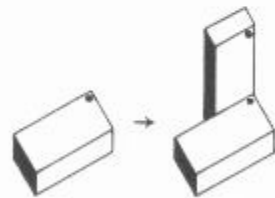

regla



diseño

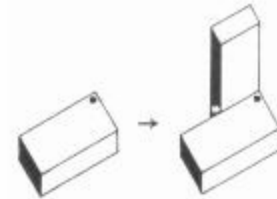

regla

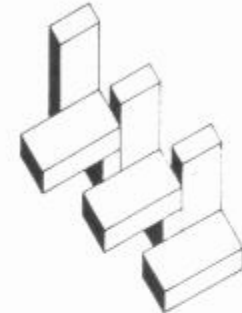

diseño

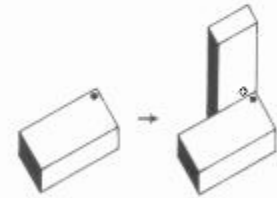

regla

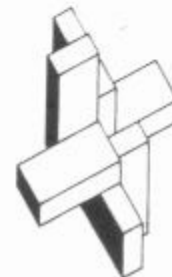

diseño

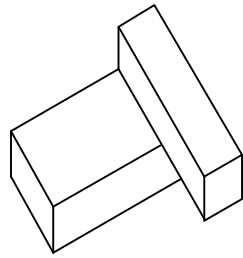

relación espacial $A + B$ entre un rectángulo y un pilar

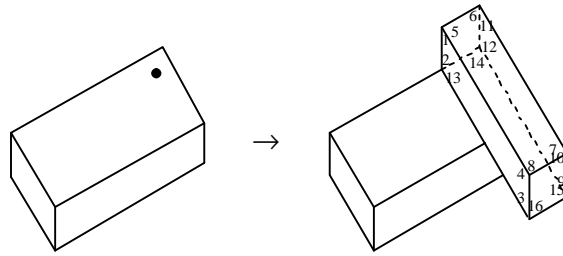

diferentes etiquetados de una regla $A \rightarrow A + B$

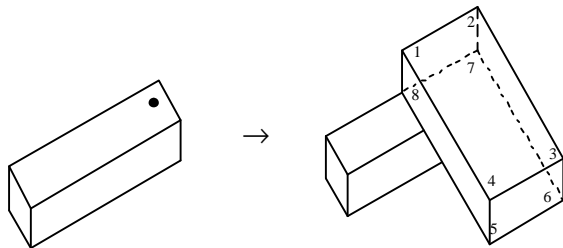

diferentes etiquetados de una regla $B \rightarrow A + B$

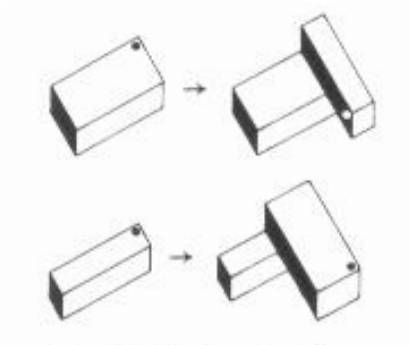

reglas

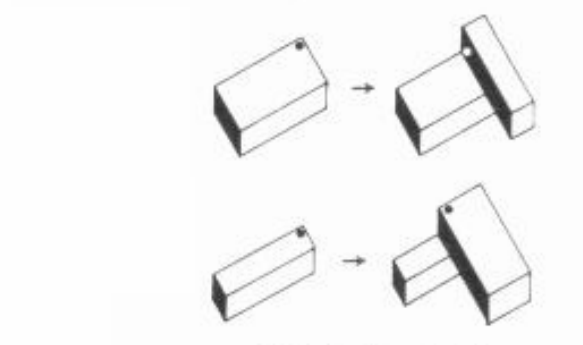

reglas



diseño

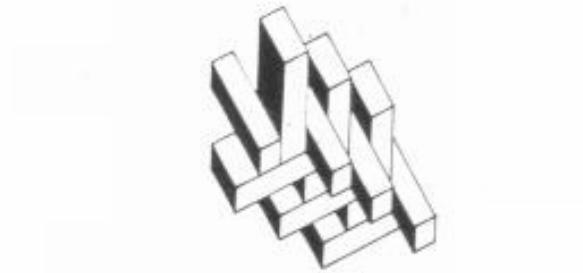

diseño

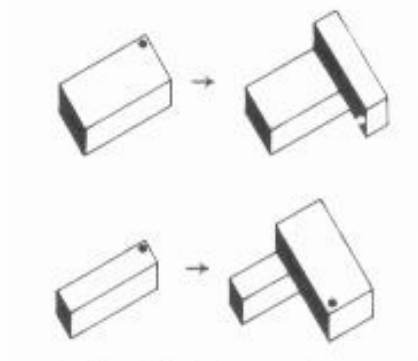

reglas

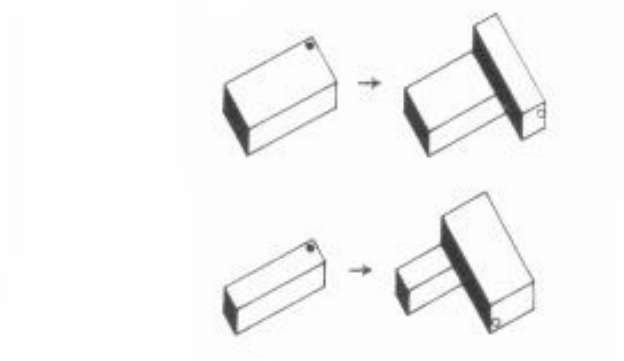

reglas

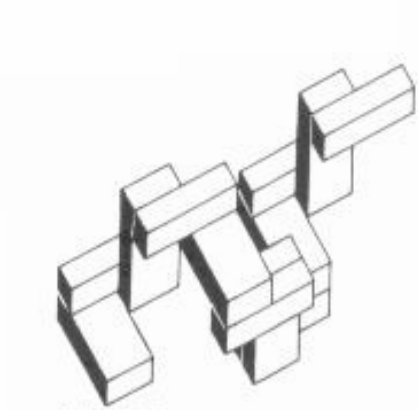

diseño

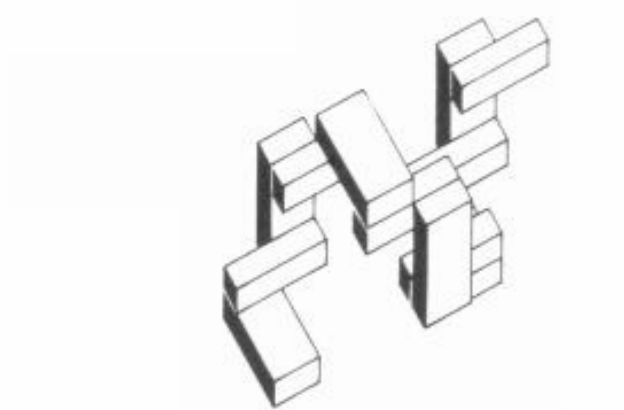

diseño

Trabajo

- Practique utilizando las gramáticas de formas en 3D.
- Vuelva a los ejemplos de gramática de formas de la clase e intente aplicar las reglas de etiquetado que no realizó en clase.